

**GARDINER TECHNOLOGY**

**GARDTEC**  
**5 0 0   S E R I E S**

**GARDTEC 580**

**Installation Instructions**



# Contents

Introduction	1
Planning the Control Panel Location	2
Installation	2
Cable Entries	3
Mains Supply Connection	4
Terminal Block Connections	5
Output Terminal Descriptions	6
Remote Keypad	8
Digigard Communicator Interface	8
Initial Power Up	9
Reset to Default Modes	9
System Programming	10
Programming Charts	12
Sample programming Session	15
Engineer Modes	19
Setting the System	20
Removing Zones	21
Testing the System	22
Viewing the Log	23
Setting Chime On/Off	24
Changing Engineer Codes	25
Resetting After an Alarm	26
Programmable Options Description	27
Display Messages	
System	30
Status	30
Log	31
Fault Finder	32
Specification	34
Zone Type Terminology	35

## Introduction

---

The Gardtec 580 Control Panel is a seven zone microprocessor based unit that has been designed to be suitable for domestic and small commercial installations. All zones are fully programmable by the engineer.

Upon completion of the installation the engineer may, if need be, re-program several factory set options so as to tailor the Control Panel to suit the requirements of the system.

**It should be noted that if a new four digit engineer code starts with a 9 it will be locked into the system and may only be changed by using the code again (default to factory settings will have no effect). This gives you the ability to protect your service revenue.**

The Control Panel is supplied complete with an onboard keypad. Upto four remote keypads may be fitted if required. If remote keypads are used one extra entry / exit zone may be used from the terminals within one of the keypads

All detection and output wiring is taken directly to the Control Panel, which also incorporates a 220/240V a.c connection. A transformer and adequate space for a rechargeable lead acid battery upto 7 ampere/hour is also provided.

Display of the system status is given via a twin seven segment L.E.D display on the Control Panel. This display is also echoed on all remote keypads that are fitted. The twin seven segment display has the ability to give more logical information to the user.

Keypress tamper is factory set to 24 digits (without a valid code number) before the tamper is activated. During unset conditions this will cause an internal alarm and during a set condition it will cause a full alarm.

We recommend that this engineers manual and the user manual are read and fully understood before any installation of the system is carried out. You will find that a little time spent now understanding the product will be a great time saver for the future.

## Planning the Control Panel Location

---

Consideration in locating the fixing position of the Control Panel should be given to:

The underside position of the lid securing screw with relation to the cover fitting and removal.

Access for the routing of cables for the system from detection devices, sounders (internal and external), remote keypads, mains, etc.

The fixing of a 3 amp unswitched fused spur.

Operation of the onboard keypad.

Readability of the display.

## Installation

---

Slacken the cover screw located on the lower edge of the Control Panel but do not remove completely.

Pull the lower edge of the cover forward and upwards in one movement. Store cover in a safe place.

Although the main P.C.B (Printed Circuit Board) is protected by the plastic moulding we would recommend that it is removed until the rear portion of the Control Panel is fixed to the wall.

To do this remove the speaker wires from the terminal block. Unclip the P.C.B from one of the side clips and lift clear of the other side clip with a sideways motion. Unplug the a.c/battery connection from the underside of the P.C.B. Store the P.C.B in a safe place.

Mark the fixing position on the wall (one upper hanger and two fixing holes) using the Control Panel backplate as a template. Under no circumstances should you drill whilst holding the backplate in position.

Fix to the wall using appropriate wall plugs and No.8 screws at least 30mm long. Do not tighten the screws at this stage, wait until all your wiring is in place.

## Cable Entries

The cable entries can be seen in Fig 1. below. It should be noted that when the larger of the two cable entry slots below the speaker housing is used the cables will tend to lie flat and side by side. This will make the task of tightening the fixing screws and getting the panel to 'lie flat' to the wall easier.

**Fig 1. GARDTEC 580 Backplate.**

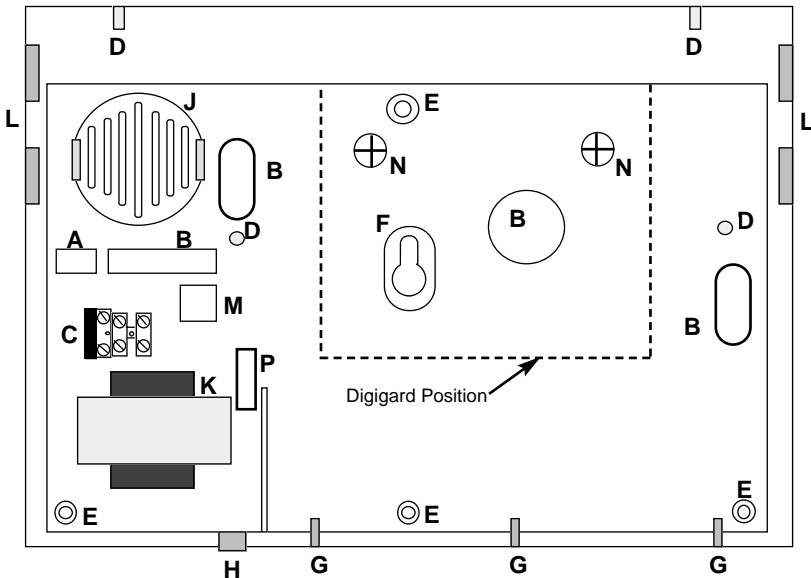

**KEY:**

- |                                |                                 |
|--------------------------------|---------------------------------|
| A = Mains entry                | H = Cover fixing screw          |
| B = Low voltage cable entry x4 | J = Speaker enclosure           |
| C = Mains connector            | K = Transformer                 |
| D = P.C.B Supports x4          | L = P.C.B Retaining clips       |
| E = Fixing screw holes x4      | M = Rear tamper switch position |
| F = Fixing screw hanger        | N = Digigard retaining lugs x2  |
| G = Battery Retaining Lugs     | P = Spare fuse holder           |

## Mains Supply Connection

---

A 220/240V a.c supply should be taken directly from the consumer unit. In order to comply with the requirements of B.S 4737 this should be via a 3 Amp unswitched fused spur. This is shown in Fig 2. below.

**Fig 2. Mains Supply Connection**

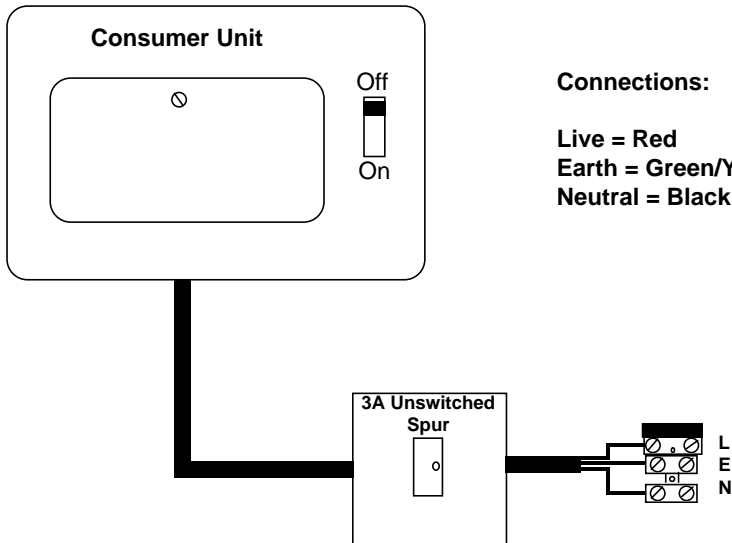

# Terminal Block Connections

Fig 3. below shows the connections for a typical system.

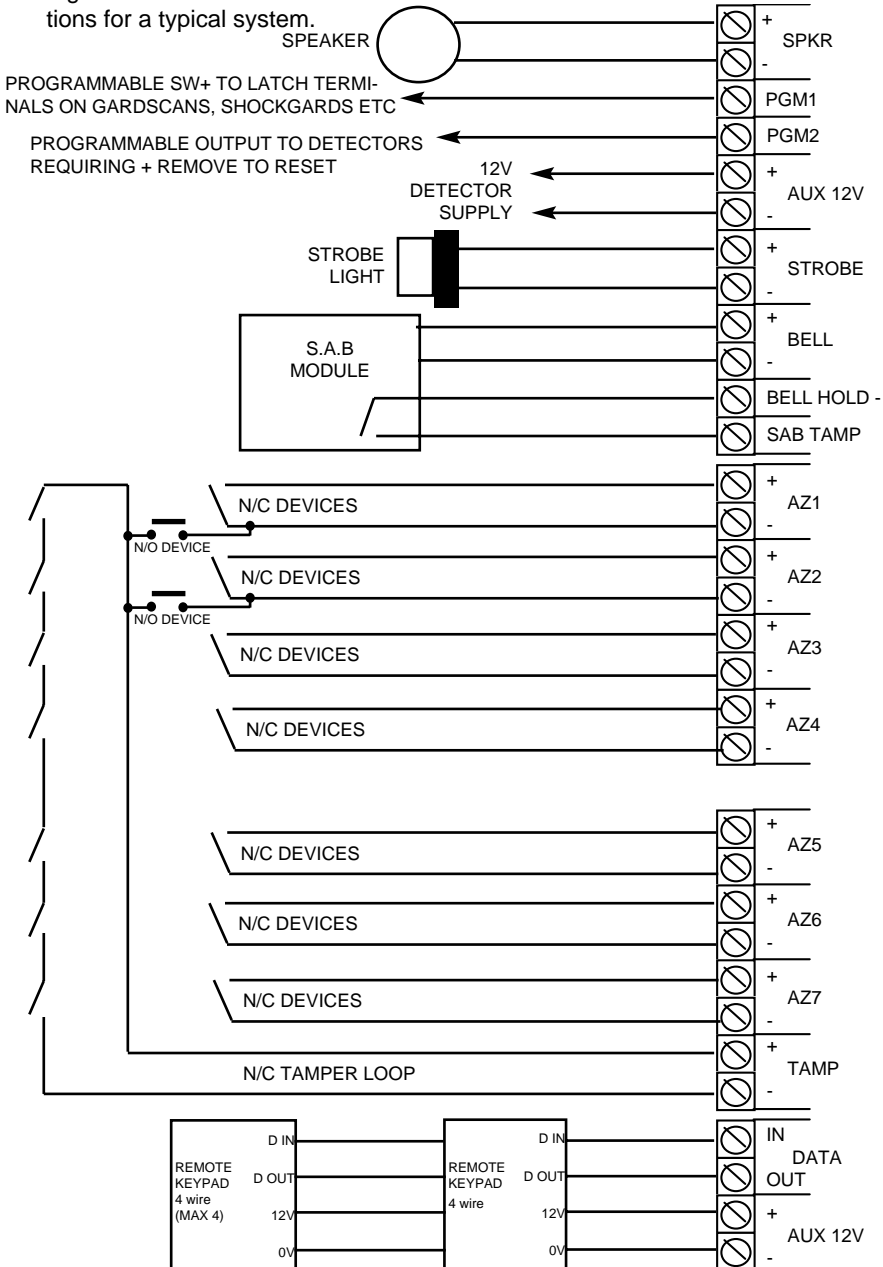



## Output Terminal Descriptions

---

### Speaker Terminals

One speaker is fitted as standard to the GARDTEC 580 and a speaker is supplied in each keypad. If an extension speaker is required it should have a minimum impedance of 16 . Both of the speakers should be wired in series format as shown in Fig 4.

**Fig 4. 2 x Speakers**

Coarse adjustment of the low volume tones is achieved through adjustment of the onboard potentiometer situated to the right of fuse F2 on the PCB edge. Fine adjustment is via the software option 'Sounder Levels'

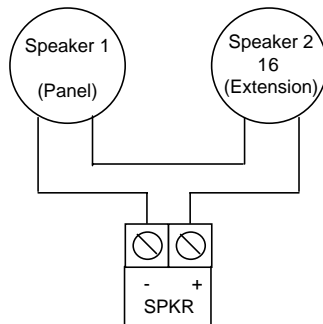

### PGM 1 Terminal

This terminal provides the switch +ve (or set +ve) required by most types of latching detectors. The terminal is an open collector output held at 12V through an integral 1k resistor. Max current sink into this terminal is 50mA. This terminal is programmable for other uses (as shown in PGM2) if required.

### PGM 2 Terminal

This terminal provides a switched 12V output and is programmable by the engineer from the list below. The terminal would normally be used with latching detectors that require the power to be removed to reset. Max current source from this terminal is 50mA

#### PGM Options

Pulse On	Switch +ve (set +ve)	Pulse Off
Bell	Strobe	Exit / Entry
Test	Int Alarm	

A more detailed description is given in the programmable options description.

## Output Terminal Descriptions (cont)

---

### Power Supply Rating

*It should be noted that the Gardtec 580 has 1 Amp available for the full system. Sounders, detectors and other auxiliary items should be included when calculating current drawn by the system. Any damage caused through overloading the Control Panel will not be covered by the warranty.*

### AUX 12V Terminals

This pair of terminals supply the + and - supply for detectors such as Gardscan P.I.Rs, Shockgard vibration sensors, etc. 1 Amp is available from these terminals (see power supply rating above).

### Strobe Terminals

This pair of terminals are the output for the strobe light. The negative terminal is switched during an alarm period. It should be noted that after an alarm, the strobe will overrun after the bell has reset until the system is unset. A maximum of 500mA may be drawn from these terminals (see power supply rating above).

### Bell Terminals

This pair of terminals are the output for the Bell or external sounder. The negative terminal is switched during an alarm period. A maximum of 1 Amp may be drawn from these terminals (see power supply rating above).

## Remote Keypads

---

Upto four remote keypads may be fitted to the GARDTEC 580 control panel. The GARDTEC 580 LED RKP has a twin seven segment display, backlit keypad and an integral speaker.

One extra Entry / Exit zone may be used from any one of the RKPs increasing the number of available zones to eight. Terminals to facilitate both the extra zone and associated tamper are included within the remote keypad.

A four core connection will be required between the control panel data port and remote keypad(s), we would advise that all keypads are in a 'daisy chain' format.

Full instructions for connection are included with the RKPs.

## ProDigi Communicator

---

The ProDigi communicator may be fitted to the GARDTEC 580 Series control. A four core connection will be required to the control panel data port. The ProDigi must be the first device in the 'daisy chain' line between the control panel and any other remote devices.

The ProDigi will require programming from a GARDTEC 800 Series control panel or a ProDigi programmer. A ProDigi programmer is available at all Gardiner Technology branches for customer use.

## Initial Power Up

---

When the Control Panel is initially powered up it will be either set or unset dependent on the state of the Control Panel when it was powered down. The factory default state will be unset.

As power is applied segments of the twin seven segment display will be lit for approx six seconds. During this period press 4 6 YES NO to ensure that the Control Panel is at factory settings. The display will then show set or unset.

## Reset to Default Modes

---

Two methods may be used to reset the Control Panel back to factory defaults.

### Method 1

Remove the cover from the Control Panel (this will cause a tamper Cb on display and sounder).

Remove the link marked LK1 on the edge of the P.C.B module (this will give temporary access to the default codes 5678 for user and 1234 for engineer)

Enter the factory default user code 5678 to stop the sounder.

**If you wish to re-program the user code**, enter this code again to enter user mode and follow the user instructions for changing user codes. **You must replace LK1 before you enter the new code.**

**Or if you wish to re-program an engineer option**, enter the factory default engineer code (1234) and press YES to gain access. **Then replace LK1** and follow the engineer programming instructions.

### Method 2

Apply power to the panel and press 00 within the first 5 seconds.

Down power the again and leave for at least 10 seconds.

Re-apply either the mains or battery supply.

Press 4 6 YES NO within the first 5 seconds.

The Control Panel is now back to factory defaults.

**Note: The two methods shown above will have no effect on the engineer code if it started with a '9'. If this is the case, only re-use of the programmed engineer code will allow it to be changed.**

## System Programming

---

The system may be programmed by the engineer by use of the engineer code (1234 factory default). Other functions are also available to the engineer, these are as follows.

### **Set**

The engineer may fully set the system or partset the system.

### **Unset**

The engineer may only unset the system using the engineer code if it has previously been set using the engineer code.

### **Remove**

The engineer may remove individual zones when setting the system.

### **Test**

The engineer may use this function to test the system.

### **Log**

Using this function the engineer may read the log. The log will be shown on a last event first basis.

### **Chime**

Using this function the engineer may turn the chime function on and off. It should be noted that chime zones must first be programmed from the engineer zone option.

The above options will be dealt with in the section Engineer Modes

Fig 6. shows the flow chart to be used when programming the GARDTEC 580

# System Programming (cont)

Fig 6. Programming Flow Chart

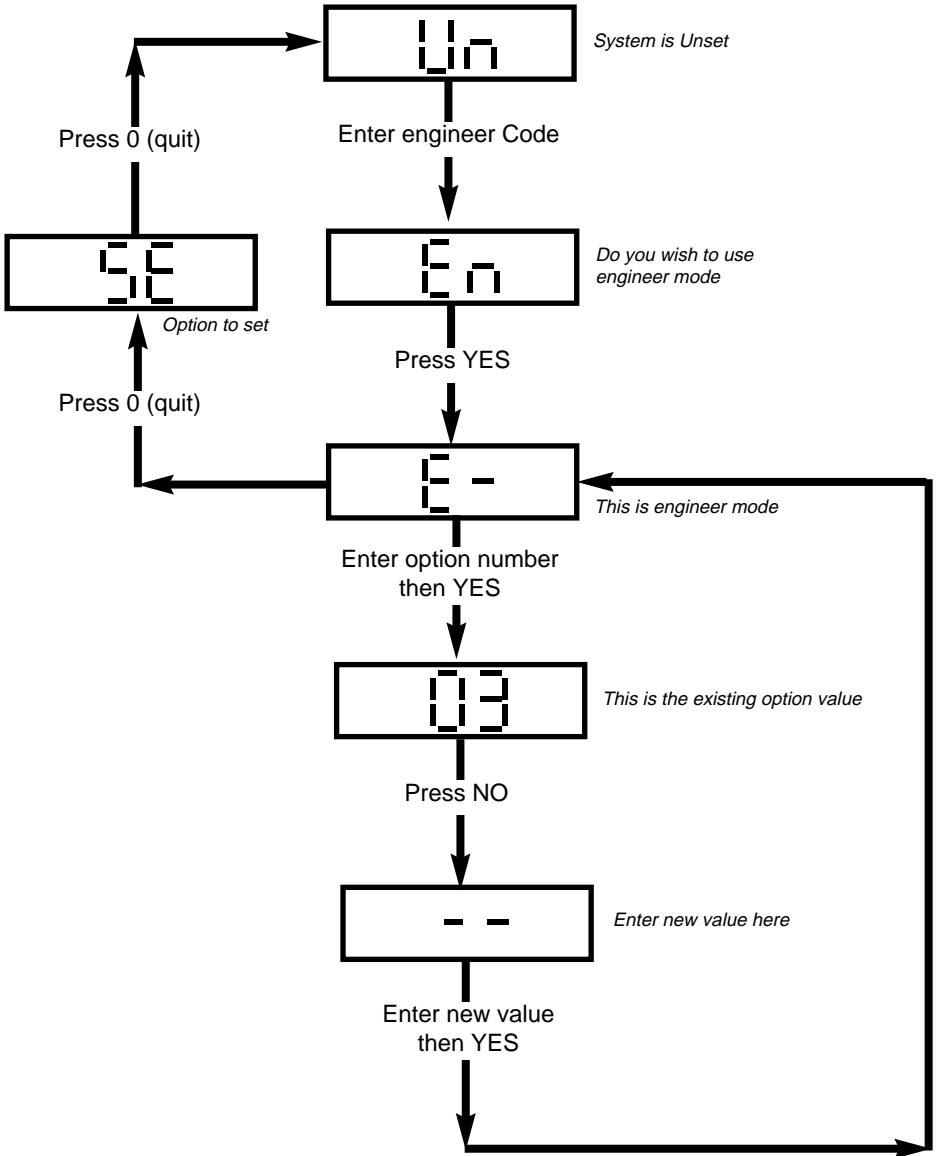

## Programming Charts

MENU	FUNCTION	OPTIONS AVAILABLE		DEFAULT
<b>No</b> 1	Zone1 Attributes	<b>LEFT DIGIT</b> 0=12Hr 1=E/E 2=Access 3=Panic 4=24Hr 5=Fire 6=Alert 7=Exit Term 8=Part E/E The terminology used for zone types is given on page 35	<b>RIGHT DIGIT</b> 0=Full Set 1=Part1 2=Part2 3=Part1&2 4=Full Set+Chime 5=Part1+Chime 6=Part2+Chime 7=Part 1&2+Chime	14
2	Zone 2 Attributes	<b>As Zone1 Options</b>		80
3	Zone 3 Attributes	<b>As Zone1 Options</b>		00
4	Zone 4 Attributes	<b>As Zone1 Options</b>		01
5	Zone 5 Attributes	<b>As Zone1 Options</b>		02
6	Zone 6 Attributes	<b>As Zone1 Options</b>		00
7	Zone 7 Attributes	<b>As Zone1 Options</b>		30
8	Sounder Level	<b>CHIME LEFT DIGIT</b> 0 - 9	<b>ENTRY/EXIT RIGHT DIGIT</b> 0 - 9	55
9	Full Set Exit Time	00 - 99seconds		30
10	Part Set Exit Time	00 - 99seconds		30
11	Setting Modes	<b>FULL SET LEFT DIGIT</b> 0=Exit Term 1=E/E Door 2=Time 3=Time+E/E	<b>PART SET RIGHT DIGIT</b> 0=Exit Term 1=E/E Door 2=Time 3=Time+E/E	22

**Programming Charts (cont)**

MENU	FUNCTION	OPTIONS AVAILABLE		DEFAULT
No 12	Part Set Sounders & Output 1 Mode	<b>PART SOUNDERS LEFT DIGIT</b>  0=All Parts silent 1=Part 2 silent 2=Parts1&3 silent 3=All Parts Audible	<b>PROGRAMMABLE OUTPUT 1 RIGHT DIGIT (PGM1)</b>  0=Pulse On 1=SW+ 2=Pulse Off 3=Bell 4=Strobe 5=Entry/Exit 6=Test 7=Int. Alarm	31
13	Entry Time 1	00 - 99seconds		30
14	Entry Time 2	00 - 99seconds		10
15	Keypad	<b>ALERT KEYS LEFT DIGIT</b>  0=Off 1=Panic 2=Fire 3=Alert	<b>RIGHT DIGIT</b>  Always 0	10
16	Bell Re-Arms	00 Re-Arms - 99 Re-Arms		99
17	Bell Ring Time	00 minutes - 99 minutes		20
18	Bell Delay Time	00 minutes - 99 minutes		00
19	Bell Mode	<b>BELL TYPE LEFT DIGIT</b>  0=SAB 1=SCB	<b>TAMPER RING RIGHT DIGIT</b>  0=Off 1=On	00



## Programming Charts (cont)

MENU	FUNCTION	OPTIONS AVAILABLE		DEFAULT
No 20	P.A and Output 2 Mode	<b>SILENT P.A LEFT DIGIT</b> 0= Audible P.A 1= Silent P.A	<b>PROGRAMMABLE OUTPUT 2 (PGM2) RIGHT DIGIT</b> 0=Pulse On 1=SW+ 2=Pulse Off 3=Bell 4=Strobe 5=Entry/Exit 6=Test 7=Int. Alarm	02
21	Reset Modes	<b>LEFT DIGIT</b>  Always 0	<b>RESET MODE RIGHT DIGIT</b>  0=Any Code 1=Master Code 2=Anti-Code 3=Engineer Code	00
22	Service Timer	00weeks - 98weeks. 99 = Off		99

## Sample Programming Session

In this sample programming session we will see how to change the following options.

Change zone 3 to be an Entry/Exit zone with chime.







Change zone 4 to be a part Entry/Exit zone, full set

Change zone 6 so it is removed (omitted) when the system is part 1 set.







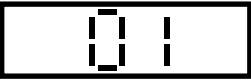

Change keypad alert keys to Fire

Change bell on time to 15 minutes.











Change the engineer code (1234) to 2580. **Note: If your new engineer code starts with a '9' resetting the unit back to factory defaults will not reset the engineer code.**

Action	Display Shows	Result
		The system is Unset
Enter the Engineer Code		Do you want to use Engineer mode
Press YES		This is Engineer mode (waiting for an option number)
Enter 3 (option for zone3 attributes) followed by YES		This is the current attribute for option 3
Press NO		This allows a new value to be entered.
Enter 14 (E/E Full set + Chime) followed by YES Note we will turn the chime function ON later		This has now returned us to the point where an option number is entered
		Continued on next page>





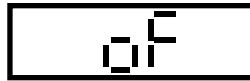

Sample Programming Session (cont)

Action	Display Shows	Result
Enter 4 (option for zone4 attributes) followed by YES		This is the current attribute for option 4
Press NO		This allows a new value to be entered.
Enter 80 (Part E/E Full set) followed by YES		This has now returned us to the point where an option number is entered
Enter 6 (option for zone6 attributes) followed by YES		This is the current attribute for option 6
Press No		This allows a new value to be entered.
Enter 01 (12Hr Part1) followed by YES		This has now returned us to the point where an option number is entered
Enter 15 (option for keypad) followed by YES		This is the current attribute for option 15
Press NO		This allows a new value to be entered.
Enter 20 (Alert keys=Fire Remote Keypad=Off) followed by YES (keys 1&3 pressed together will now act as Fire (pulsed sounders)).		This has now returned us to the point where an option number is entered  Continued on next page>

**Sample Programming Session (cont)**

Action	Display Shows	Result
Enter 17 (option for Bell Ring Time) followed by YES		This is the current attribute for option 17
Press NO		This allows a new value to be entered.
Enter 15 (the new time in minutes) followed by YES		This has now returned us to the point where an option number is entered
The Engineer code is not programmed from this mode. To gain access to the Engineer code option Press 0 (Quit)		This is asking do you want to set the system
Press NO		This is asking do you want to remove zones
Press NO		This is asking do you want to test the system
Press NO		This is asking do you want to view the log
Press NO		This is asking do you want to turn the chime ON or OFF
Press YES		This is showing the chime function is turned OFF
Press NO		The chime function is now turned ON

Sample Programming Session (cont)

Action	Display Shows	Result
Press YES		This is asking do you want to turn chime ON or OFF again
Press NO		This is asking do you want to program user code (in this case engineer)
Press YES		This is asking for a new engineer code
Enter your new code (digits will show on display as you enter them). Followed by YES. <b>If first digit is 9 code will be locked into system (see page 1).</b>		This is asking you to repeat your new code
Re-Enter your new code followed by YES. A comfort tone will be generated each time the YES key is pressed to show that all is O.K. If no tone is generated a mistake has been made or the codes do not match. In cases were no tone is generated the code will not be updated.		This is asking if you wish to program the engineer code again.
We have now finished this programming session. Press 0 (quit) to return the system to unset		The system is now unset

# Engineer Modes

The flow chart for accessing the other engineer options are shown in Fig 7.

Fig 7. Engineer Modes Flow Chart

### KEY TO SCREENS:-

- Un = Unset
- En = Engineer Mode
- SE = Set
- r E = Remove Zones
- t E = Test System
- Lo = Read Log
- Ch = Change Chime
- Uc = User Code

When the screen is flashing this should be interpreted as "DO YOU WANT TO"  
**Pressing 0 (quit) when any screen in Fig 7 is flashing will return the system to unset.**

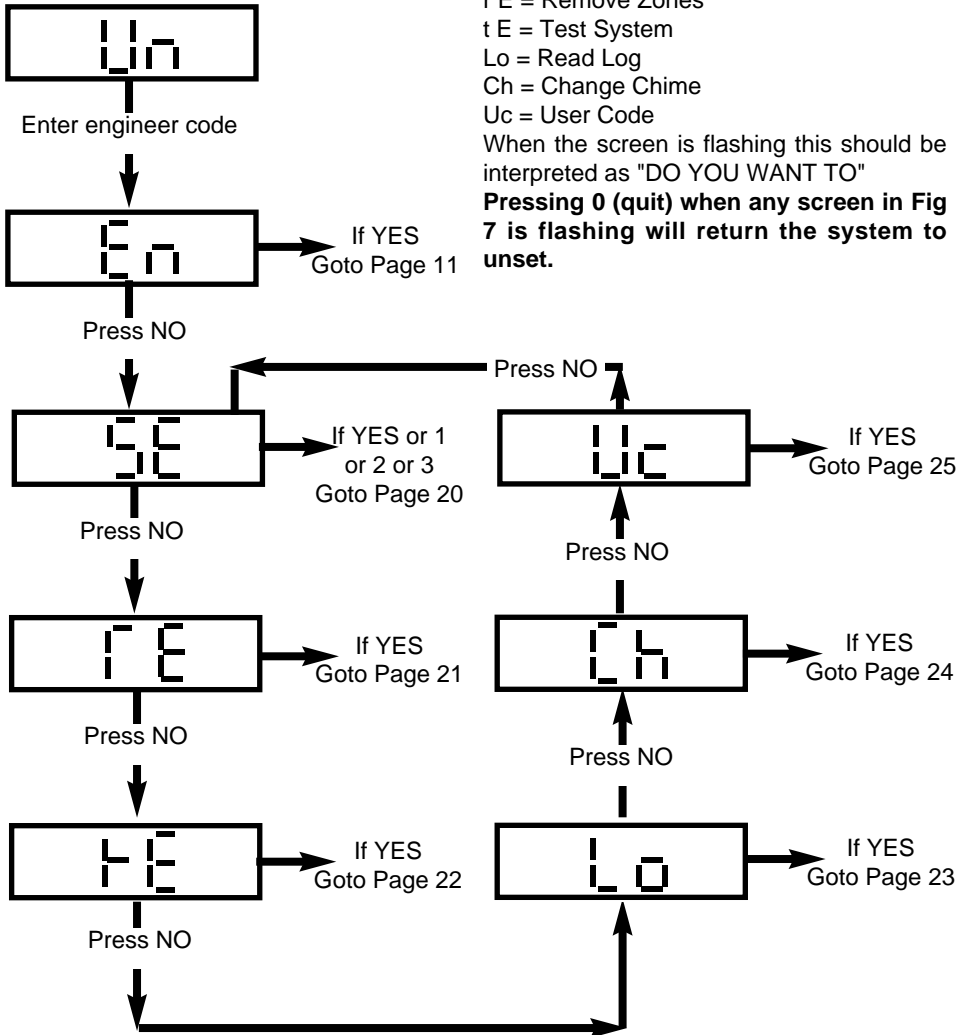

## Engineer Modes (Setting the System)

Fig 8. Setting Flow Chart (continued from page 19)

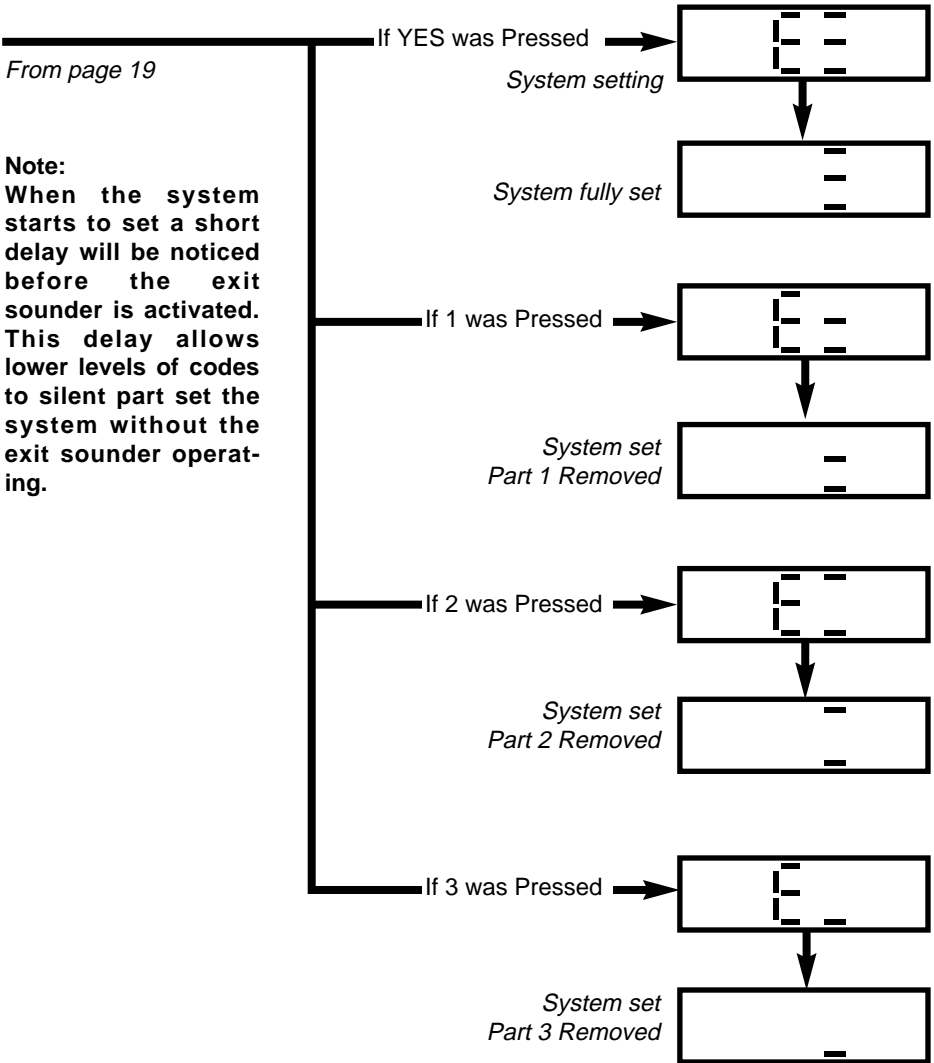

To unset system or abort setting during exit Re-enter code.

# Engineer Modes (Removing Zones)

Fig 9. Removing Zones

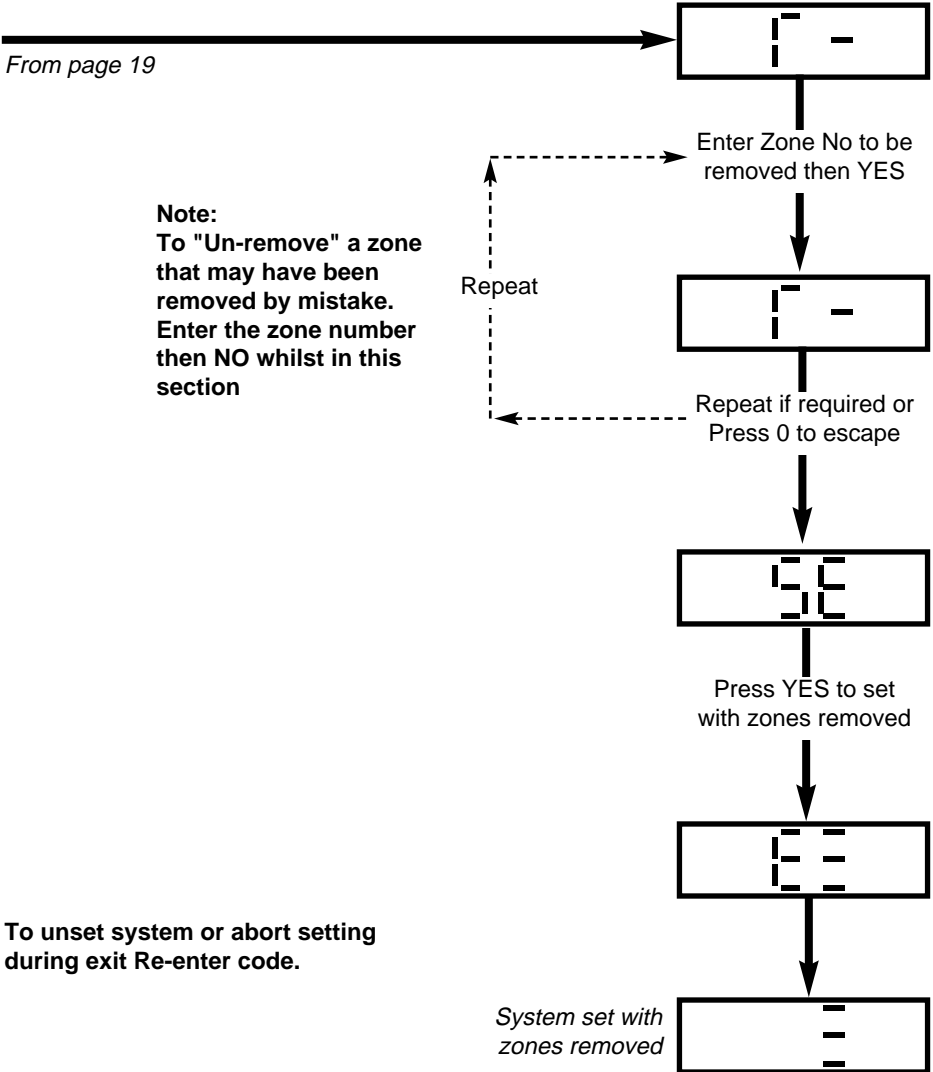



## Engineer Modes (Testing the System)

---

Fig 10. Testing the System

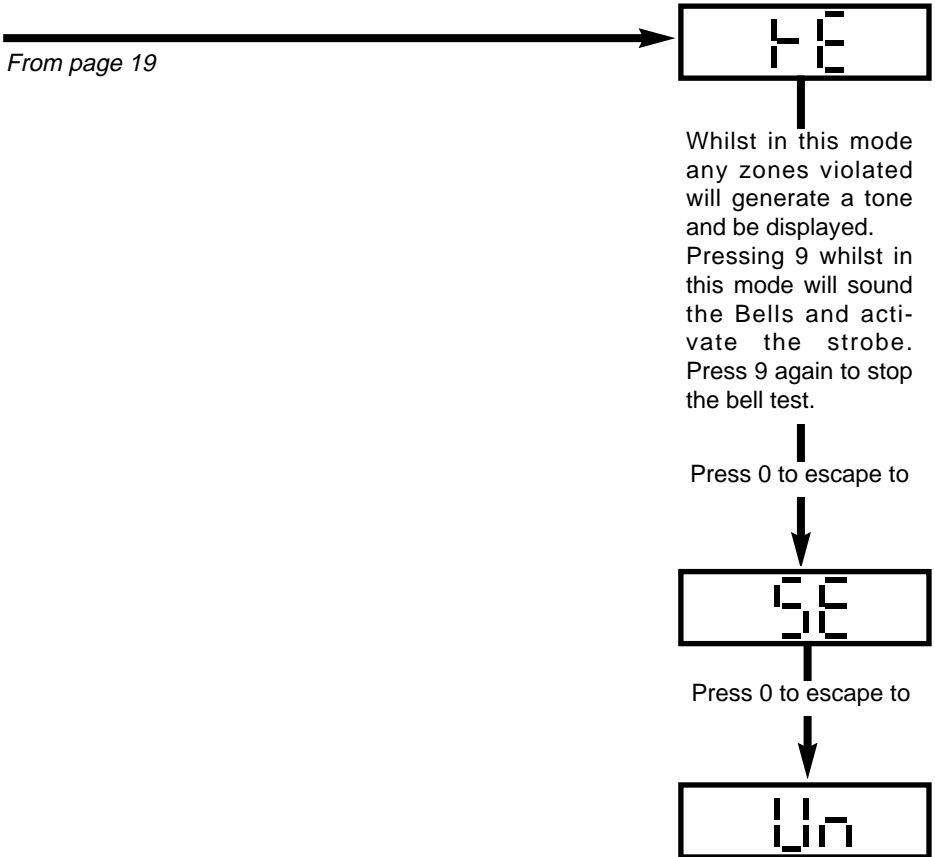

## Engineer Modes (Viewing the Log)

---

Fig 11. Viewing the Log

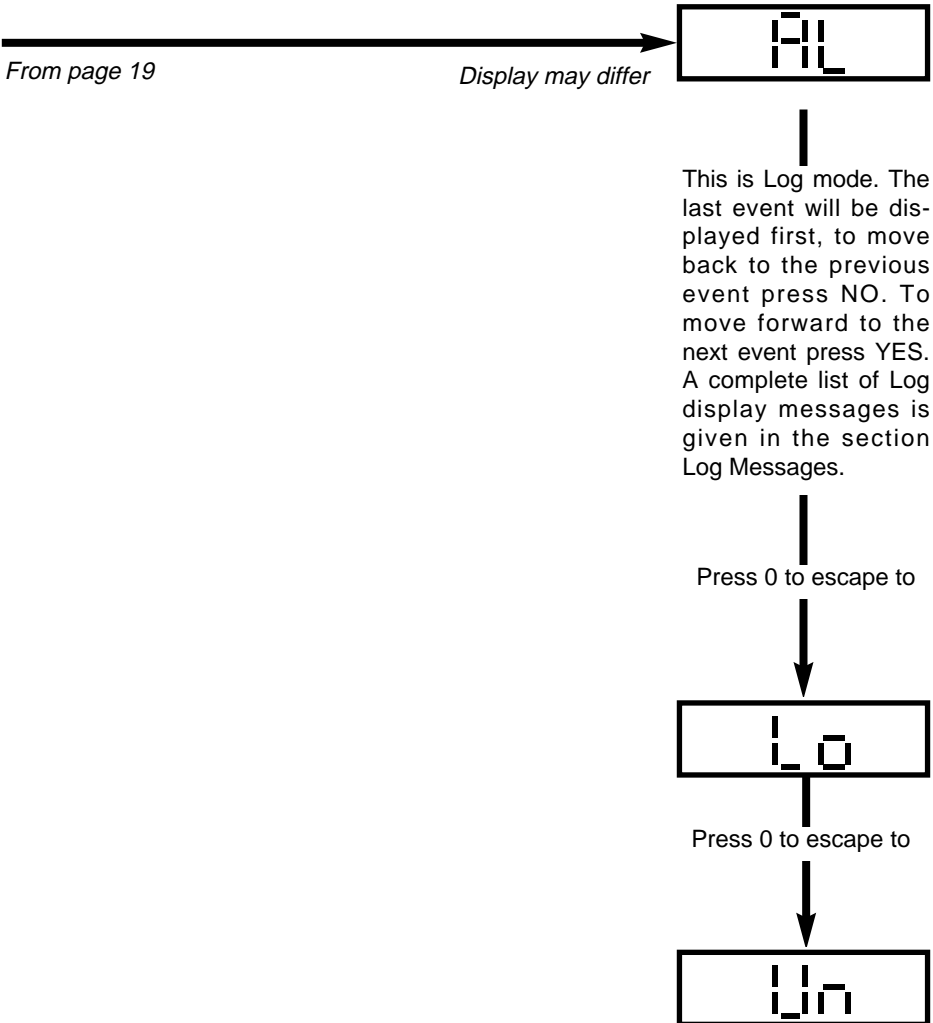

## Engineer Modes (Setting Chime On/Off)

---

Fig 12. Setting Chime On/Off

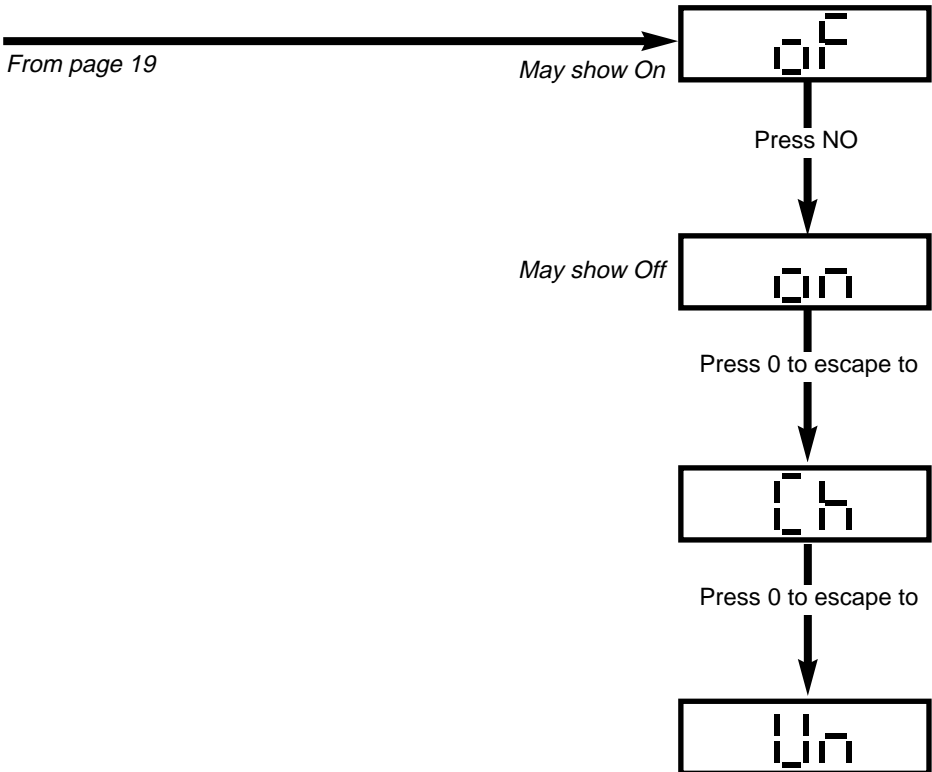

## Engineer Modes (Changing Engineer Code)

---

Fig 13. Changing Engineer Code

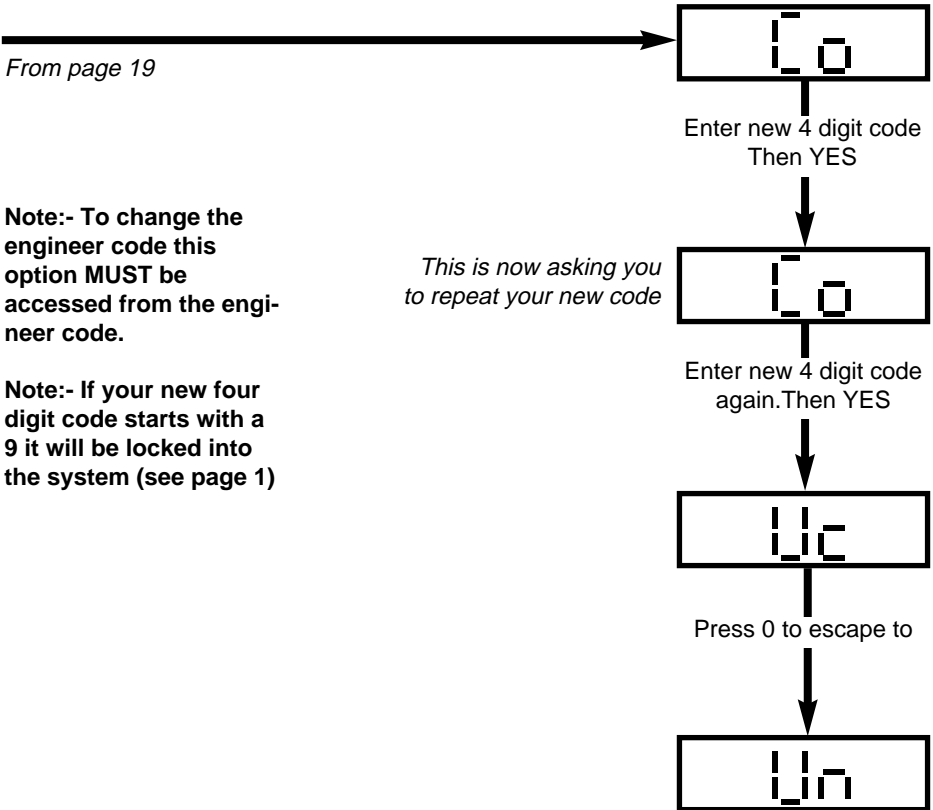

From page 19

**Note:-** To change the engineer code this option **MUST** be accessed from the engineer code.

**Note:-** If your new four digit code starts with a 9 it will be locked into the system (see page 1)

*This is now asking you to repeat your new code*

## Resetting After an Alarm

---

Four reset modes are available after an alarm. These are as follows.

### Any Code

The system will reset the next time Any Code is used to set the system.

### Master Code

The system will only reset if the Master Code or Engineer code is used to set the system.

### Engineer Code

The system will only reset if the Engineer Code is used to set the system.

### Anti-Code

The system may only be reset by use of an Anti-Code.

### To Reset System:-

Enter Code of correct type (see above).

Proceed to set the system.

If a set is not required re-enter the code to abort setting.

### To Reset by Anti-Code:-

Make a note of the Code given by the display.

Using the Gardiner Technology Anti-Code software on a P.C enter the four digits given by the Panel.

The resulting Anti-Code is then entered into the Control Panel to reset it.

**Note: This resulting code may also use the YES and NO keys.**

## Programmable Options Description

---

This section will give a description of the programmable options that are available on the GARDTEC 580 Control Panel. For more details of the parameters available for each option please refer to the section Programming Charts starting at page 12.

### **Zone 1 Attributes (Option No.1)**

This option allows the zone type, zone part set remove and zone chime features to be programmed for zone 1.

### **Zone 2 Attributes (Option No.2)**

This option allows the zone type, zone part set remove and zone chime features to be programmed for zone 2.

### **Zone 3 Attributes (Option No.3)**

This option allows the zone type, zone part set remove and zone chime features to be programmed for zone 3.

### **Zone 4 Attributes (Option No.4)**

This option allows the zone type, zone part set remove and zone chime features to be programmed for zone 4.

### **Zone 5 Attributes (Option No.5)**

This option allows the zone type, zone part set remove and zone chime features to be programmed for zone 5.

### **Zone 6 Attributes (Option No.6)**

This option allows the zone type, zone part set remove and zone chime features to be programmed for zone 6.

### **Zone 7 Attributes (Option No.7)**

This option allows the zone type, zone part set remove and zone chime features to be programmed for zone 7.

## Programmable Options Description

---

### **Sounder Level (Option No.8)**

This option allows for the fine adjustment of the speaker volume for Entry/Exit tone and Chime to be programmed. Coarse adjustment is via the potentiometer situated to the right of the PCB edge.

### **Full Set Exit Time (Option No.9)**

Allows the Exit Time for full set to be programmed.

### **Part Set Exit Time (Option No.10)**

Allows the Exit Time for part set to be programmed.

### **Setting Modes (Option No.11)**

Allows the setting modes for Full and Part-set to be programmed.

### **Part-set Sounders & Output 1 Mode (Option No.12)**

Allows the Part-set exit sounder modes and the operating modes of the programmable output 1 terminal to be programmed.

### **Entry Time 1 (Option No.13)**

Entry time may be looked at as three events. Entry time 1 will give the normal Entry tone. Entry time 2 will give a louder warning tone. After both time1 & time 2 has expired the external sounders will sound. This option allows Entry Time 1 to be programmed.

### **Entry Time 2 (Option No.14)**

Allows Entry Time 2 to be programmed.

### **Keypad (Option No.15)**

Key numbers 1 & 3 when pressed together may be programmed using this function to give a particular response.

### **Bell Re-Arms (Option No.16)**

This option is used to program the number of times the Bell will Re-Arm during a set period.

### **Bell Ring Time (Option No.17)**

This option is used to program the Bell ring time. Some local authorities may have by-laws that reduce the Bell ring time below the national environmental limit of 20 minutes. Your local authority Environmental Health department will be able to give information relating to your area.

## Programmable Options Description

---

### **Bell Delay Time (Option No.18)**

Bell Delay Time is a delay in minutes from the alarm being activated to the Bell ringing. This function would normally be used in conjunction with a digital communicator.

### **Bell Mode (Option No.19)**

The Bell Mode Function allows the mode of the Bell to be programmed from SAB to SCB. In SAB mode the current for the sounder is supplied from the Control Panel unless the cable to the Bell box is cut. In SCB mode the current for the sounder is supplied by the sounder battery under all circumstances. The Bell Tamper mode is also programmed using this option.

### **P.A & Output 2 Mode (Option No.20)**

The P.A may be programmed for silent or audible using this option. The output mode of the programmable output 2 terminal is also programmed using this option.

### **Remote Signal and Reset Modes (Option No.21)**

The remote signal and reset modes are programmed using this function.

### **Service Timer (Option No.22)**

The service timer period is programmed using this function. When service time expires the system will lock the user out. Extra service may be gained using the Anti-Code software. If the timer is set to 99 weeks the timer function is Off.



## Display Messages (System)

---

The Following System messages are possible.

'1 to 7'	Represent zones 1 to 7
'r1'	RKP zone
't'	Tamper zone
'CA'	Console (Control Panel) Alert keys activated
'Fb'	Fuse Fail or Battery Fault
'bb'	Bell box Tamper
'Cb'	Control Box Tamper
'Pc'	Mains Power Cut
'Ct'	RKP Tamper / E.O.L resistor missing or cable cut to RKPs
'Ac'	Anti-Code reset required (Engineer reset will override)
'PL'	Line fault / Fail to communicate.

## Display Messages (Status)

---

'Un'	System is Unset (Day Mode)
'E ≡'	System Full Setting
'E ='	System Part 1 Setting
'E 二'	System Part 2 Setting
'E -'	System Part 3 Setting
' ≡'	System Fully Set
' ='	System Part 1 Set
' 二'	System Part 2 Set
' -'	System Part 3 Set
'AL'	An Alarm has occurred (Press NO to view cause).

## Display Messages (Log)

---

Apart from the System and Status displays the following messages may also appear whilst viewing the Log.

'S ≡'	System Full Set
'S ='	System Part 1 Set
'S ≡'	System Part 2 Set
'S _'	System Part 3 Set
'o1'	Unset User 1
'o2'	Unset User 2
'o3'	Unset User 3
'o4'	Unset User 4
'o5'	Unset User 5
'o6'	Unset User 6
'o7'	Unset User 7
'o8'	Unset User 8
'o9'	Unset User 9
'o0'	Unset User 0 (Engineer)
'AL'	Alarm has occurred
' 1 to 7 ' (flashing)	Zone 1 to 7 was removed when system was set.
'rE'	Watchdog reset

## Fault Finder

FAULT	ACTION
Control Panel will not power up from the mains supply.	Check/Replace fuse in fused spur/mains connection block. Also check for trapped wiring insulation.
Display shows a zone fault and Panel will not set after exit time has expired.	Remove zone wires from the problem zone at Control Panel and replace with a link. Check if panel now sets. If all is O.K check with a multimeter the continuity of the wires you have removed. Also check that there is no short circuit between the zone and tamper loop or the zone and 0V.
Control Panel gives a tamper fault .	Link out the tamper loop that is displaying the fault and recheck. If all is O.K test continuity of the faulty loop. Also check for short circuits to other cores of the cable.
Tripping a detector does not cause an alarm and is not registered at the Control Panel.	Check for short circuits on the problem zone. If two detectors are fitted to the same zone try tripping them both at the same time to determine that they are wired in series.
External sounder does not sound.	Use a multimeter or small buzzer across the Bell + & - terminals to determine if the Control Panel is firing the Bell. If all is O.K check the operation of the sounder by removing the wiring at the sounder and connecting the system battery.
External sounder rings without the Control Panel triggering it.	Disconnect the Nicad battery from the SAB of the sounder. Check to see if the hold off voltage from the Control Panel is present at the SAB, if not check/replace Control Panel fuse. If fuse is O.K check hold off voltage at Control Panel with wiring removed. If hold off voltage O.K check replace wiring/SAB.

## Fault Finder (cont)

FAULT	ACTION
<p>Tamper is not tripped when detector cover is removed.</p> <p>Detectors false alarm.</p>	<p>Check that the tampers are in series. If all is O.K check for short circuits. Remember short circuits are easily caused through staples piercing cables.</p> <p>Check that the position of the detector is in accordance with the manufacturers recommendations.</p> <p>In the case of a P.I.R ensure that the unit is not facing a window or situated in a draughty location</p> <p>In the case of a shock sensor ensure that it is not bridging any joints.</p> <p>In the case of a contact check the gap and that there is no excessive movement of the protected item.</p> <p>Check also that low voltage alarm cables do not run parallel to mains cables. Where they do so they should be at least 9 inches apart, when crossing they should do so at 90°</p>
<p>Control Panel shows Lid Tamper when cover is in place.</p>	<p>Check the tamper spring is attached to the tamper switch on the PCB module.</p>
<p>Control Panel parameters are unchanged after programming.</p>	<p>Check that LK1 is in place on the PCB.</p>
<p>User and or Engineer code have been forgotten.</p>	<p>Access may be gained to the system by removing LK1 and using factory default codes (replace LK1 after access has been gained).</p> <p>The system may be reverted to factory defaults as shown on page 9</p>

## Gardtec 580 Specification

---

Power Input	240V a.c +/- 10% @50Hz
Max Loop Resistance	2K
Loop Delay Time	300 milliseconds
Fuses	
Mains	200mA Quick Blow
Aux	1A Quick Blow
Gard	250 mA Quick Blow
Low Voltage Output	13.8V (typical) Regulated
Power Supply Rating	1A
Battery Sizes	12V 1.2A, 12V 3.0A, 12V 7.0A
Construction	3mm Polycarbonate
Complies with	B.S 4737
Number of Zones	7 + Tamper + 1 E/E from RKP's
Display Type	2 x 7 segment LED
User Code Default	5678
Engineer Code Default	1234
Event Log Size	80

## Zone Type Terminology

---

The terminology used for the various zone types are explained in this section.

12 Hour	Zone active when Control Panel is Set
Access	Will allow to pass through on Exit. Will allow to pass through on entry only if entry/exit is opened first
24 Hour	Internal sounder if Unset. Full alarm if Set.
Entry/Exit	Zone used as last exit point Will start entry time when opened if panel is Set
Part E/E	As Access if Control Panel is Full Set As entry/exit if Control Panel is Part Set
P.A	24 Hour Personal Attack. Active if Control Panel is Set or Unset
Alert	Internal sounder only Recorded to Log
Fire	Will give Fire alarm when activated (pulsed sounders) with panel set or unset.
Exit Terminator	With Panel programmed to set with exit terminator the panel will only set when zone is activated during exit.



# GARDINER TECHNOLOGY

**Gardiner Technology Ltd**  
Queensway, Rochdale  
Lancashire, OL11 1TQ  
United Kingdom

Tel: 01706 510000  
Fax: 01706 510100

Technical Support Tel: 01706 510200  
Technical Support Fax: 01706 510204  
Mon-Fri 09:00 - 17:30



Certificate No.935289